

Cromo 100 1jet 28580000

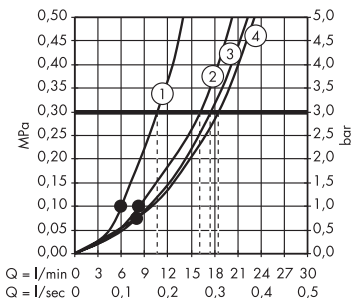

Cromo 100 Vario 28535000



Massage Shampoo Normal Rain

5

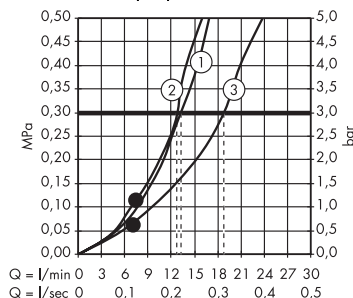

Cromo 100 Multi 28536XXX



Massage Mono Rain

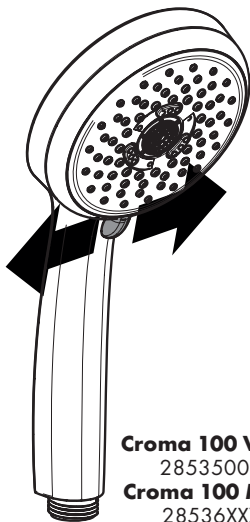
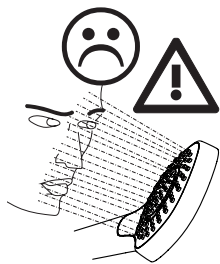
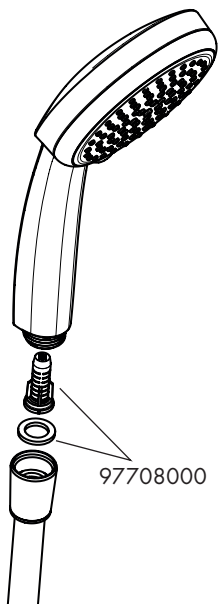

Cromo 100 Vario
28535000
Cromo 100 Multi
28536XXX

	P-IX	DVGW	NF
26826400	P-IX 7512/IB	CM0350	X
28535000	P-IX 18335/ID	CM0350	X
28536XXX	P-IX 18336/ID	CM0350	X

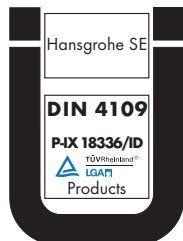

hansgrohe

Hansgrohe · Auestraße 5 - 9 · D-77761 Schiltach
Telefon +49 (0) 78 36/51-1282 · Telefax +49 (0) 7836/511440
E-Mail: info@hansgrohe.com · Internet: www.hansgrohe.com

09/2019
9.04213.07

hansgrohe

- DE** Montageanleitung
- FR** Instructions de montage
- EN** assembly instructions
- IT** Istruzioni per Installazione
- ES** Instrucciones de montaje
- NL** Handleiding
- DK** Monteringsvejledning
- PT** Manual de Instalação
- PL** Instrukcja montażu
- CS** Montážní návod
- SK** Montážny návod
- ZH** 组装说明
- RU** Инструкция по монтажу
- HU** Szerelési útmutató
- FI** Asennusohje
- SV** Monteringsanvisning
- LT** Montavimo instrukcijos
- HR** Uputstva za instalaciju
- TR** Montaj kılavuzu
- RO** Instrucțiuni de montare
- EL** Οδηγία συναρμολόγησης
- SL** Navodila za montažo
- ET** Paigaldusjuhend
- LV** Montāžas instrukcija
- SR** Uputstvo za montažu
- NO** Montasjeveiledning
- BG** Инструкция за употреба
- SQ** Udhëzime rreth montimit
- AR** تعليمات التجميع

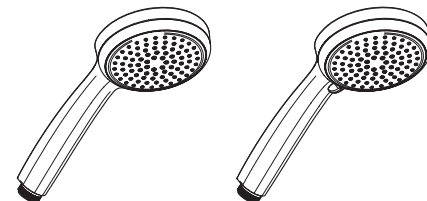

Cromo 100 1jet
28580000

Cromo 100 Vario
28535000

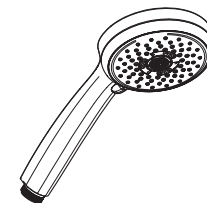

Cromo 100 Multi
28536XXX

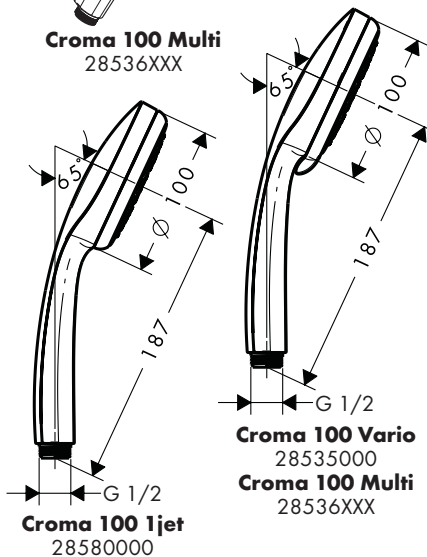

Cromo 100 Vario
28535000
Cromo 100 Multi
28536XXX

Cromo 100 1jet
28580000

- DE** Reinigungsempfehlung / Garantie / Kontakt
FR Recommandation pour le nettoyage / Garanties / Contact
EN Cleaning recommendation / Warranty / Contact
IT Raccomandazione di pulizia / Garanzia / Contatto
ES Recomendaciones para la limpieza / Garantía / Contacto
NL Aanbeveling inzake reiniging / Garantie / Contact
DK Rensning, anbefaling / Garanti / Kontakt
PT Recomendações de limpeza / Garantia / Contacto
PL Zalecenie dotyczący pielęgnacji / Gwarancja / Kontakt
CS Doporučení k čištění / Záruka / Kontakt
SK Odporúčania pre čistenie / Záruka / Kontakt
ZH 清洁指南 / 担保 / 接触
RU Рекомендации по очистке / Гарантия / Контакты
HU Tisztítási tanácsok / Garancia / érintkezés
FI Puhdistussuositus / Takuu / Kosketus
SV Rengöringsrekommendationer / Garanti / Contacto
LT Valymo rekomendacijos / Garantija / Kontaktai
HR Preporuke za čišćenje / Garancija / Kontakt
TR Temizleme önerisi / Garanti / Temas
RO Recomandări pentru curățare / Garanție / Contact
EL Σύσταση καθαρισμού / Εγγύηση / επαφή
SL Priporočilo za čiščenje / Garancija / Kontakt
ET Puhastussuovitused / Garantii / Kontakt
LV Tīrīšanas ieteikumi / Garantija / Kontakti
SR Preporuke za čišćenje / Garancija / Kontakt
NO Anbefaling for rengjøring / Garanti / Kontakt
BG Препоръка за почистване / Гаранция / Контакт
SQ Këshilla rreth pastrimit / Garancia / Kontakt
KO 세정시 권장사항 / 품질보증 / 접촉
AR توصيات التنظيف / الضمان (الولايات المتحدة الأمريكية) / اتصال



www.hansgrohe.com/cleaning-recommendation

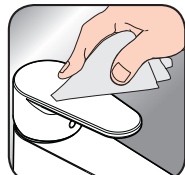

www.hansgrohe.com/cleaning-recommendation



www.hansgrohe.com/cleaning-recommendation



www.hansgrohe.com/cleaning-recommendation

Service

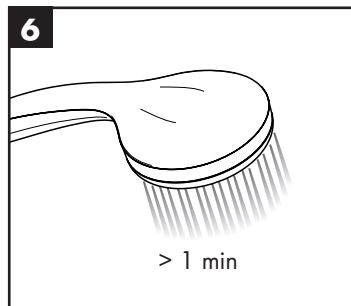
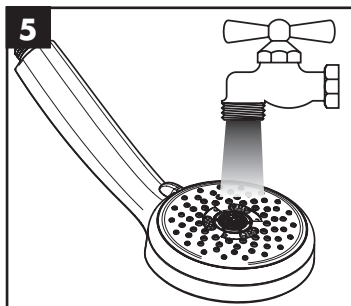
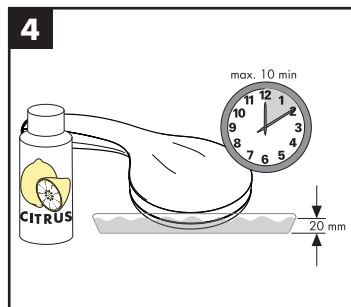
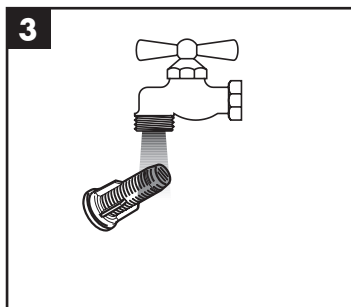
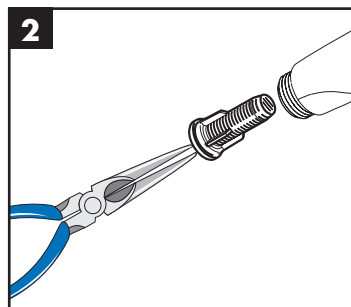
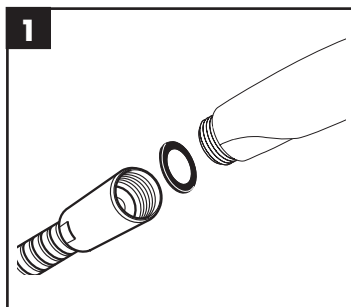

- DE** Einfach sauber: Kalk lässt sich von den Noppen ganz leicht abrubbeln.
FR La propreté en toute simplicité: les dépôts formés sur les buses élastiques en silicone s'éliminent par un simple passage de la main.
EN Just clean: simply rub over the spray nozzles to remove lime scale.
IT Facile da pulire: Il calcare viene eliminato semplicemente dagli ugelli elastici in silicone.
ES Fácil aseo: La cal se puede retirar sencillamente frotando con los dedos de las toberas elásticas de silicona.
NL Eenvoudig schoon: Kalk kan eenvoudig van de noppen worden gewreven.
DK Enkel rengøring: Det er let at fjerne kalkaflejringer fra stråledyserne.
PT Simplesmente limpo: o calcário pode ser simplesmente retirado das saídas através de fricção.
PL Po prostu czysto: Pęczki można całkiem łatwo oczyścić z kamienia.
CS Jednoduše čistě: Vapenné usazeniny můžete z nopek snadno odstranit ořením.
SK Jednoducho čistý: Vodný kameň sa dá zo štetín celkom ľahko odstrániť.
ZH 清洁: 只需要揉搓花洒表面的出水孔即可去除水垢。
RU Простота чистки: известь очень легко стирается с утолщений.
HU Egyszerűen tiszta: a vízkő egészen könnyen ledörzsölhető a csomókról.
FI Yksinkertaisesti puhdas: kalkin voi helposti hieroa irti nypystä.
SV Enkelt att göra rent: det är lätt att ta bort kalk från nopporna.
LT Paprasta švara: kalkės lengvai nugarandomos nuo kilpos.

- HR** Jednostavno čisto: Kamenac se sasvim lako uklanja s izbočina.
TR Sadece temiz: Kireç, düğümlemlerle kolayca ovalanabilir.
RO Pur și simplu curat: Calcarul se îndepărtează ușor de pe noduri prin frecare.
EL Απλά τέλεια καθαριότητα: Τα άλατα μπορούν να αφαιρεθούν με μεγάλη ευκολία από τα στόμια.
SL Preprosto čisto: arpenec se z lahkoto podrgne z vozličkov.
ET Lihtsalt puhas: lujja saab nuppu delt lihtsalt maha hõõruda.
LV Vienkārša tīrīšana: kaļķis no izvirzījumiem ir viegli norubināms.
SR Jednostavno čisto: Kamenac se sasvim lako skida sa izbočina.
NO Simpelten ren: Ved å gnikke er det lett å fjerne kalk fra nuppene.
BG Просто чисто: Варовикът лесно може да се изтърси от удебеленията.
SQ Thjesht dhe pastër. Mbetjet gëlqerore mund të hiqen me fërkim të lehtë.
AR إنه سهل التنظيف، حيث يسقط الجير بسهولة شديدة من الأجزاء الناتئة

